

Lubrication Unit NSK K1™

Used on NSK Linear Guide™, Ball Screws and Monocarrier™



NSK Patent

Twenty years of proven efficiency in providing lubrication



Lubrication unit NSK K1™ for food processing and medical equipment is also available.

Lubrication Unit NSK K1™

- NSK K1 lubrication unit equipped with an NSK linear guide, ball screw and Monocarrier is an outstanding new lubrication material.
- A Newly developed porous synthetic resin contains large volume of lubricant oil that seeps out and enhances lubricating function.

NSK K1 lowers machine operation cost, and reduces impact on the environment. NSK K1 is a lubrication device which combines oil and resin in a single unit. The porous resin contains a large amount of lubrication oil. Touching its surface to the raceway of a rail close to the ball contact point NSK K1 constantly supplies fresh oil which seeps from the resin.

You can achieve the following:

- Long-term maintenance-free (cost reduction)
 - Long life under severe environments
 - Environmentally sound clean lubrication system
- Lubricant oil and polyolefin combined and molded into one unit**
- Containing 70% of lubrication oil
 - Supplies lubricant oil for long periods of time

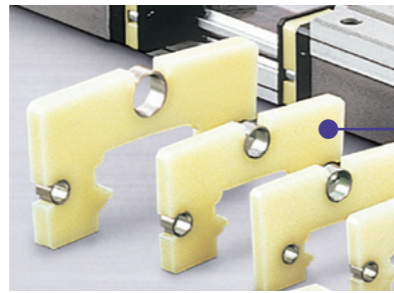

Magnification of NSK K1

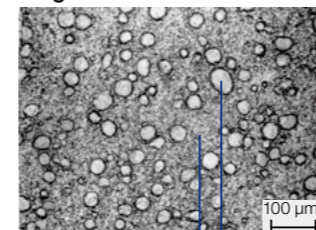

Portion containing high proportion of lubricating oil
Portion containing high proportion of polyolefin

NSK Linear Guides equipped with NSK K1

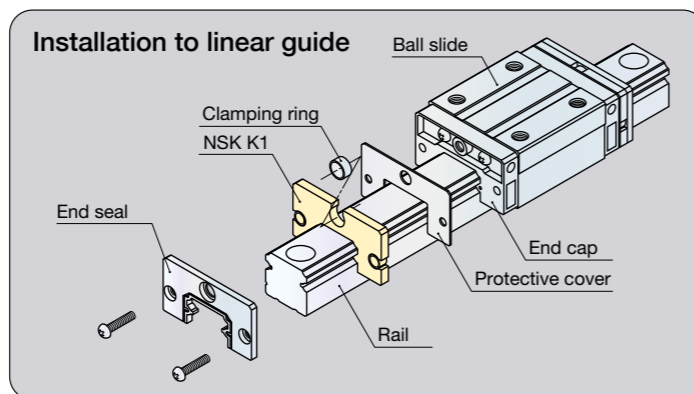
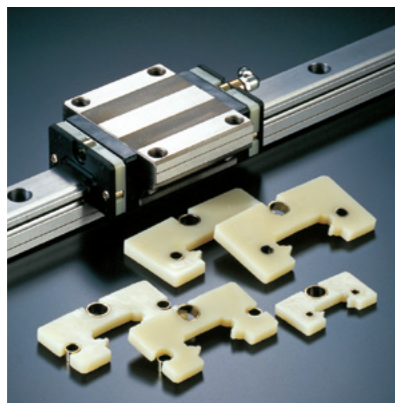

Features of NSK Linear Guides equipped with NSK K1

With the NSK K1 lubrication unit, maintenance is unnecessary for more than five years or 10 000 km. Simply attach the unit inside the standard end seal. The NSK K1 lubrication unit is also available for use with food machinery, medical equipment and peripherals in environments with strict hygienic or sanitation restrictions. See page 5 for details.

Ball Screws equipped with NSK K1

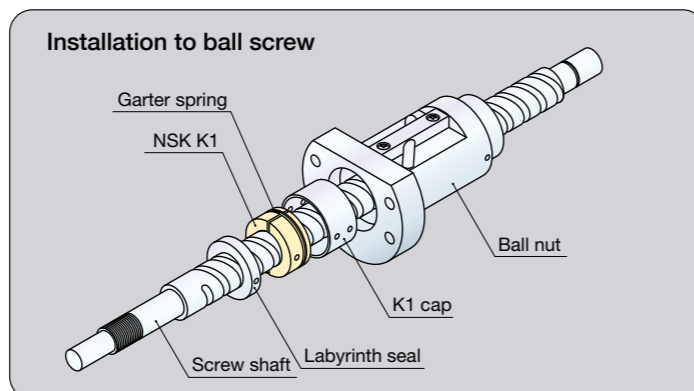
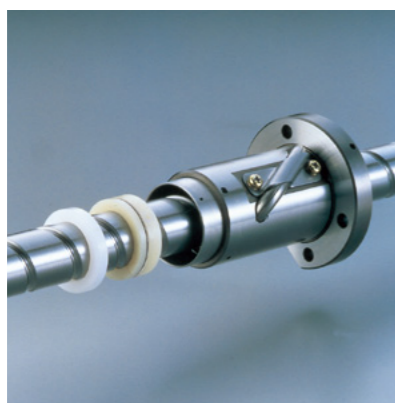

What this unit can achieve:

1 Long-Term Maintenance Free → Cost Down

We want to reduce the workload and cost of replenishing oil and grease...
We want to eliminate piping for oil supply...
We cannot suspend our production line for replenishing oil...

A lubrication system equipped with the NSK K1 lubrication unit is maintenance free for more than five years or 10 000 kilometers.

Conventional system

Supplying oil using a lubrication unit and centralized piping

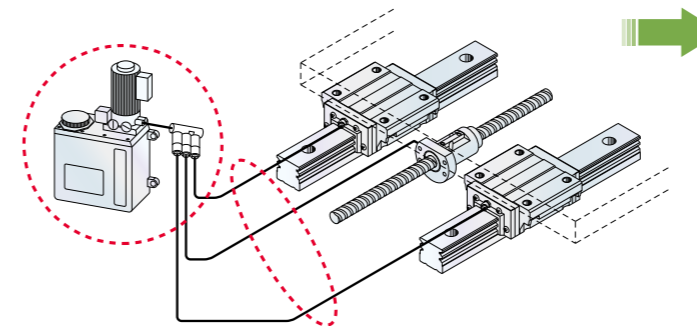

New lubrication system

Using the NSK K1 lubrication unit

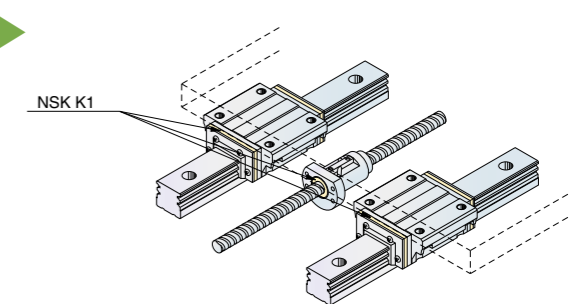

Advantages:

- A reduction in expenditure on oil or grease cost by making it unnecessary to replenish lubricants for an extended period
- A reduction in personnel costs for regular maintenance
- A reduction in the cost of designing and replenishing piping or equipment, parts expenditures, and lead time for assembly
- A reduction in the cost for coolants and in processing oil waste (No lubricant contamination → Prolonged life of coolants)

Comparison test between NSK K1 and standard seal

(1) Linear guide

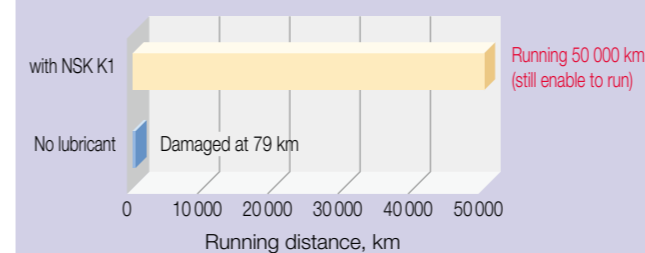

Sample: LH30 (slight preload)
Lubrication: 1) Only NSK K1
2) No lubricant
Load: None
Speed: 60 m/min
Stroke: 750 mm

(2) Ball screw

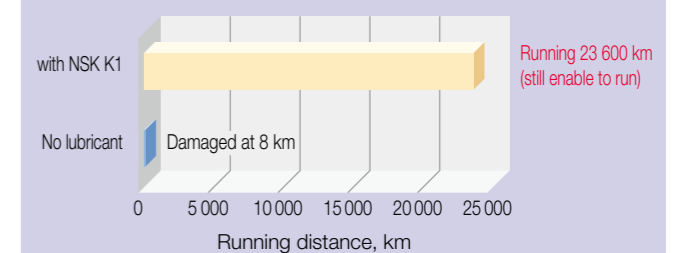

Sample: Shaft dia. 20 mm, lead 20 mm
Lubrication: 1) Only NSK K1
2) No lubricant
Load: None
Speed: 4 000 min⁻¹
Stroke: 450 mm

What this unit can achieve:

2 Long Life even in Severe Environments

- Shortened service life because of
- Contaminated environments
 - Quick deterioration of lubricants absorbed by dust
 - Lubricant deteriorates or is washed away by water seepage

Use of the NSK K1 lubrication unit significantly prolongs the life of your machinery, even in severe contaminated environments or undesirable environments for lubrication

Advantages:

- A reduction in maintenance cost, including repair parts and personnel
- Longer time between repairs → shortened down-time on the production line → Improved productivity

● Example of severe environments

- Contaminated environments; Machine tools, welding machines, etc.
- Environments where oil- and grease absorbing dust is produced; Woodworking machines, textile machines, papermaking machines, printing machines, etc.
- Environments where lubricant is washed away; Machines that are washed away entirely by water, machines that are exposed to rain or water.

Note: Rust preventive treatment is required for corrosive environments.

● Test result of ball screws in contaminated environments



Sample: Screw shaft dia. 40 mm, lead 10 mm
 Circuit: 2.5 × 1
 Lubrication: 1) AS2 Grease (packed before operation only)
 2) AS2 Grease (packed before operation only) + NSK K1
 Load: 3.9 kN
 Speed: 2 000 min⁻¹ (20 m/min)
 Stroke: 340 mm
 Contamination: Dropped contaminants onto screw shaft periodically.
 FCD45 particle 115 MESH added at coolant
 (Coolant dilution 30:1)
 Volume of contaminant: Coolant 3 600 cm³ + casting particles 1.8 g/day

Test result: abrasion on nut grooves of a ball screw (perpendicular surface) (Running distance: 1 864 km)

(1) Without NSK K1

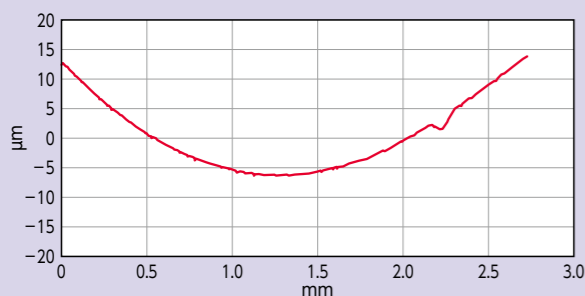

Abrasion higher than 20 µm (when abrasion is spread all over the grooves)

(2) With NSK K1

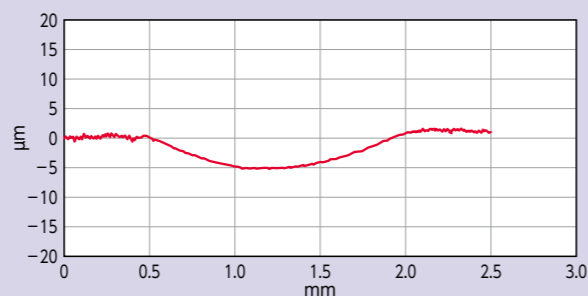

Abrasion around 5 to 6 µm (normal abrasion conditions)

Use of the NSK K1 lubrication unit has reduced abrasion of ball screws by **75%**.

What this unit can achieve:

3 A Clean Lubrication System That is Environmentally Friendly

We want to avoid contamination by oil dispersion... We don't like coolant decomposition and odor caused by lubricant oil falling into coolants.

By using the NSK K1 lubrication unit, you can solve these problems and achieve a clean and environmentally sound machinery/equipment system.

Merit

- Suitable for machinery or equipment used where exposed lubricants should be avoided, such as food processing machinery, medical equipment, or engineering and textile machinery.
- Suitable for machinery or equipment that requires extremely high levels of cleanliness, such as semiconductor and LCD fabrication-related equipment.
- Improvement of work environment

● Adjacent areas for NSK K1 installed linear guide



NSK K1 installed linear guide

Replenishing grease is not required, so machines are kept clean.

Precautions for handling

To maintain high functionality of the NSK K1, observe the following precautions.

1. Temperature range for use: Maximum temperature in use: 50°C
Momentary maximum temperature in use: 80°C
2. Chemicals that should not come into contact with NSK K1:
Do not leave the NSK K1 in an organic solvent, such as hexane and thinner that remove oil, or rust preventive oil that contains white kerosene.

Note: Water-type cutting oil, oil-type cutting oil, mineral-oil type grease and ester-type grease do not damage NSK K1.

NSK Linear Guides for Food Processing and Medical Equipment in Sanitary Environments

The NSK K1 lubrication unit for food processing and medical equipment is safe and secure. NSK K1 FDA-compliant material is used for the lubrication unit, so it is used without anxiety for food processing and medical equipment.

- The NSK K1 lubrication unit for food processing and medical equipment is a phenomenal new material seal that is safe and secure.
- The newly developed porous synthetic resin contains abundant lubricant.
- With the basic functions of highly praised NSK K1 for general industry, more sophisticated materials make it applicable in food and medical equipment.
- It also offers easy installation, mounted inside the standard end seal (rubber).



Features of NSK K1 Lubrication Unit for Food and Medical Equipment

- **Very safe to handle**
Uses highly safe materials that are compliant with the US Food and Drug Administration's (FDA) hygiene standards for food additives.
- **Environmentally sound**
The newly developed porous synthetic resin provides a controlled supply of lubricant, preventing the dispersion of oil in sanitary environments.
- **Resistant to harsh environments**
It is durable not only under normal environments, but also under harsh environments, such as machinery submerged in water.

Features of NSK Linear Guides for Sanitary Environments

- **The highest grade of category H1 grease of USDA standard is used for NSK K1 lubrication unit.**
*category H1: Lubricants permitted for use where there is possibility of incidental food contact
*USDA: USDA (The United States Department of Agriculture)
<Features of grease for food processing machines>
 - This grease is approved by USDA H1. (National Science Foundation [NSF] carries out certification for USDA.)
 - Superb water resistance and antirust capability
 - Superb wear resistance
 - Applicable for a centralized oiling system
- **Appropriate volume of grease**
A supply of appropriate volume of grease reduces grease draining and scattering, and maintains a clean environment.

The table below shows available models.

NH Series	NH15, NH20, NH25, NH30, NH35
NS Series	NS15, NS20, NS25, NS30, NS35
LW Series	LW17, LW21, LW27, LW35
PU Series	PU09, PU12, PU15
LU Series	LU09, LU12, LU15
PE Series	PE09, PE12, PE15
LE Series	LE09, LE12, LE15
Miniature LH Series	LH12

Introduction of Performance by Use

1 Automotive Manufacturing Equipment

Maintenance Free, Long Life even in Severe Environments

Actual results from welding machines, the most severe environment in automotive plants

Operating conditions

Sample: LH300200ELD1-PCZ
 No.1: Double seal + Protector (no NSK K1)
 No.2: NSK K1 attached + Single seal + Protector
 Lubrication: AV2 grease (prepacked only)
 Tested on the same welding machine in automotive production line
 Sample No.1: 10.5-month operation
 Sample No.2: 36-month operation



Comparison after running

Sample No.1 (without NSK K1)
: Rail and ball slide raceways and balls showed rust and extensive deterioration
 Sample No.2 (with NSK K1)
: Rail and ball slide raceways and balls had no rust and only slight deterioration

Ball deterioration

Sample No.1
(without NSK K1)



Sample No.2
(with NSK K1)

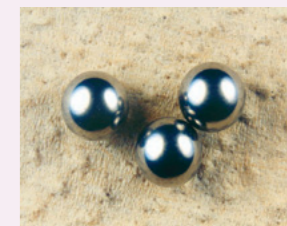

Rail raceway deterioration

Sample No.1
(without NSK K1)

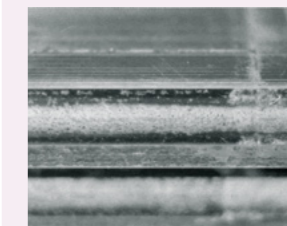

Sample No.2
(with NSK K1)

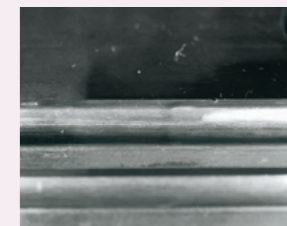

Merit

- Reduced expense for lubricants (see graph in the right)
→ **Reduced equipment cost**
- No oil or grease supply systems required
→ **No piping design required**
- Improved machine design time and efficiency
→ **Reduced maintenance cost**
- Long-term maintenance free
→ **NSK K1 reduces lubricant consumption, minimizes waste oil**

Comparison of lubricant consumption

Estimated oil consumption in the test equivalent to 5 years running (for 4 LH45 slides)

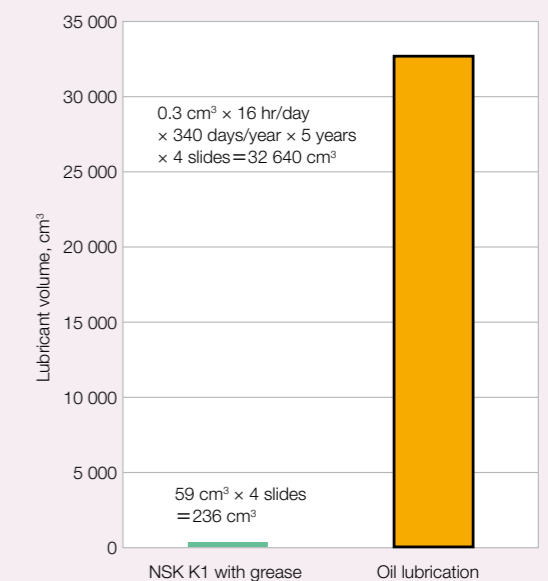

Applications

- Lifter and carrier / • Multi-tier stock systems / • Engine/chassis decking systems / • Underbody line welding machines / • Body line conveyor systems / • Marking machines / • Material handling systems / • Sorting systems / • Assembly vibration testers / • Assembly machines / • Differential gear grinding machines

Introduction of Performance by Use

2 Machine Tools

High-Load Life Test Using Cutting Coolant which is Contaminated with Cast Iron Particles

3 Samples of different lubricant conditions

Test conditions

Sample: LY45BN (Preload Z4)
 Load: 9 800 N per one ball slide
 Preload: 4 400 N Grease: AV2
 Feed: Average 24 m/min Stroke: 400 mm
 Contamination: Coolant dilution 30:1
 FCD45 particles 115 MESH (125 µm or less) added at 5% (by weight)
 Pattern: 2 days in coolant (ball grooves of rail are immersed) 5 days no coolant



Friction force change

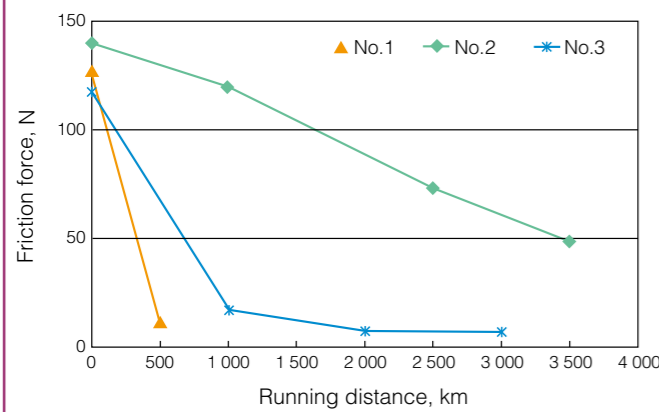

Test results

Sample	Lubricating condition (*1)	Condition			Result Distance (km) Running year (*2)
		Broken end cap	Flaking	Lost Preload	
No.1	Grease only	Yes Test stopped	No	Yes	End cap broke prematurely due to inadequate way of lubrication and particles. 600 km, 0.8 years.
No.2	NSK K1 (4 pcs.) + Grease	No	No	No	Running uninterrupted over 3 600 km, 5 years.
No.3	Oil only	No	Slight	Yes	Shortened life because of particle and inadequate way of lubrication. 3 000 km, 4.1 years.

(*1): No replenishment of grease to sample No.1 and No.2 during test.
 (*2): Running year is calculated by 720 km/year (average 3 m/min × 16 hr/day × 250 days/year).

Merit

- Reduced expense for lubricants (see graph in the right)
- No oil or grease supply systems required
→ **Reduced equipment cost**
- Improved machine design time and efficiency
→ **No piping design required**
- Better for the environment
→ **NSK K1 reduces lubricant consumption, minimizes waste oil**

Comparison of lubricant consumption

Estimated oil consumption in the test equivalent to 5 years running (for 4 LA45 slides)

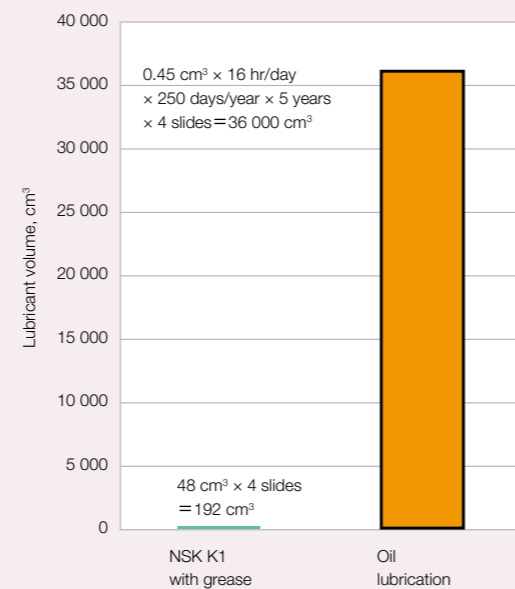

Applications

- Machining centers / • NC Lathes / • Telescopic cover for horizontal machining center / • Laser processing machines (X and Y axes) / • Pallet changer / • Water jet cutter

3 Woodworking Machines

Long Life even with Wood Chip Contamination

Life is 2 times longer than standard double seals in woodworking machines

Comparison test between NSK K1 and standard double seal

Test conditions

Sample: LH30AN (Preload Z1)
 Feed rate: 20 m/min
 Stroke: 400 mm
 Lubrication: Standard double seal - AV2 grease
 NSK K1 - NSK K1 + AV2 grease
 Load: 490 N per one ball slide
 Wood chip contamination: Set the product in the box with bottom area A, then put 240 g of wood chips on the rails. Put back removed wood chips to rails 3 times/day.
 [High volume of chips]: A = 145 mm (width) × 700 mm (length)
 [Medium volume of chips]: A = 170 mm (width) × 700 mm (length)

Running test in wood chips



Test results (high volume of chips)

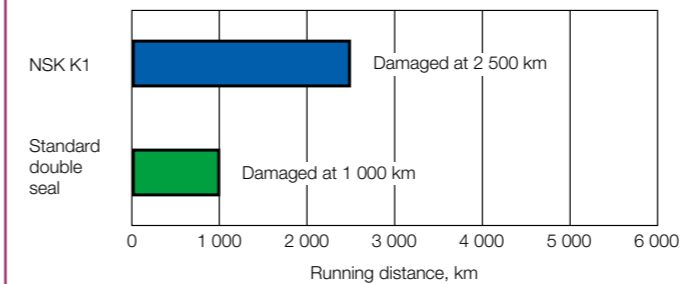

Test results (medium volume of chips)

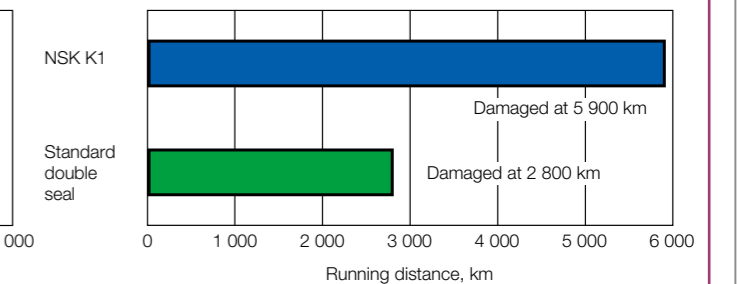

Merit

- No oil or grease supply systems required
→ **Reduced equipment cost**
- Improved machine design time and efficiency
→ **No piping design required**
- Better for the environment
→ **NSK K1 reduces lubricant consumption, minimizes waste oil**

Applications

- Router / • Lumber cutting, groove making machines / • Pre-cutting machines / • Unmanned lumbering machines

Introduction of Performance by Use

4 Semiconductor / LCD Manufacturing Equipment

Low Particle Emission

Combining the NSK K1 with LG2 grease for low particle emission is comparable to using vacuum grease.
 Test conditions
 Sample: LS20
 Speed: 36 m/min

Comparison of particle emission characteristics

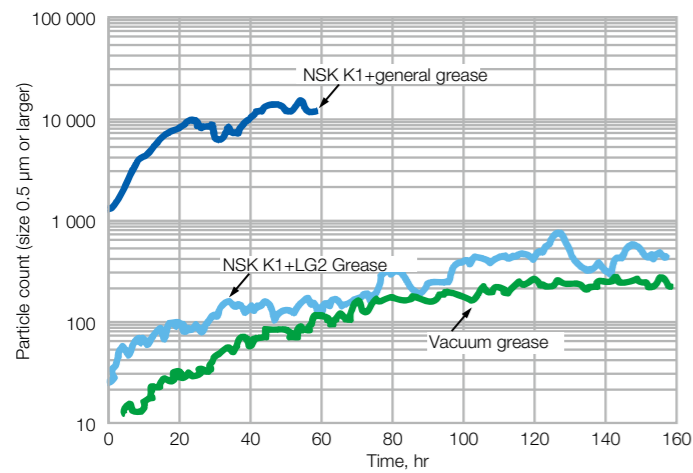

Good Operability (Stable Dynamic Friction Force)

Dynamic friction force is 1/3 of fluorine type grease (at 20 m/min).
 Test conditions
 Sample: LS20AL
 Preload: Z1

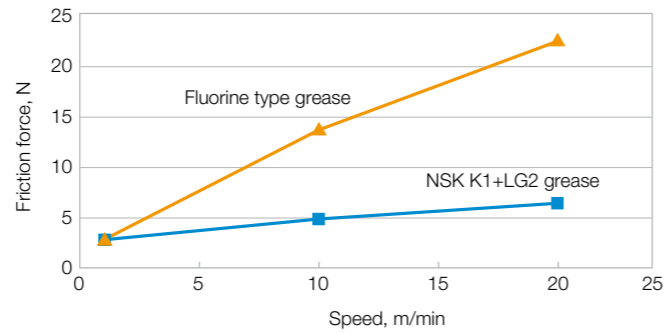

Change of dynamic friction force (100% at the beginning)

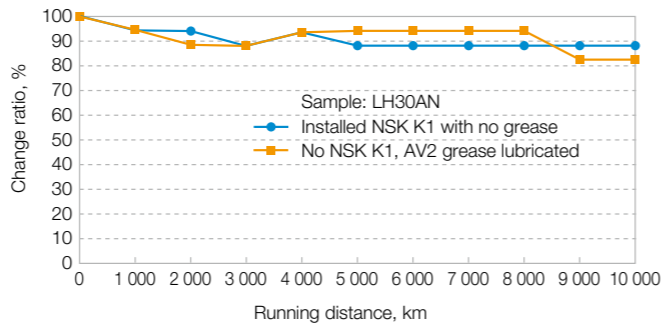

High Performance Lubrication - Maintenance free

Over 30 000 km running with only NSK K1.
 Improved performance can be expected when used with the LG2 Grease.

Endurance test without additional lubrication

Test conditions
 Sample: LH30AN
 Preload: Z1, Z3

	High speed test	Medium speed test
Speed:	200 m/min	60 m/min
Stroke:	1 800 mm	750 mm
Load:	63 N/1 ball slide	None

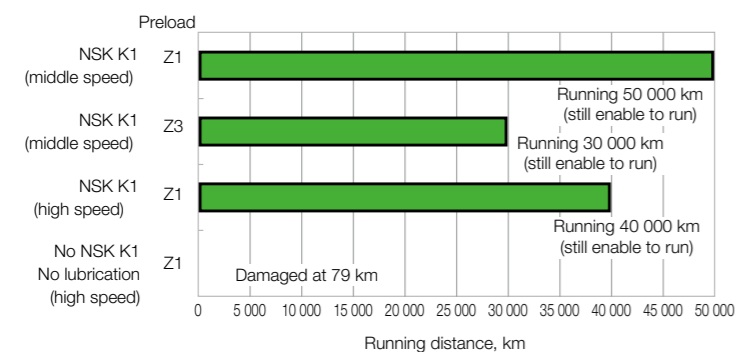

Applications

- LCD substrates polishing machines
- LCD glass substrates transporting machines
- LCD glass substrates testing equipment
- Thin film processing equipment for semiconductors
- Washing machines
- Full automatic wafer mounters
- Washing section of the wafer polishing machines
- Carrier arm section of logic handler
- CMP

5 Food Processing, Medical/Nursing Equipment

Keeps Equipment and Adjacent Areas Clean

Wear life is 3 times longer than normal seals under wet conditions.

Endurance test in water

Test conditions
 Sample: LS30 stainless steel
 Preload: Z1
 Load: 4 700 N per one ball slide
 Stroke: 400 mm
 Speed: 24 m/min
 Lubrication: Grease full pack (Consistency: 280, Viscosity: 580 cst)
 Water exposure: Run in water 1 day per week.

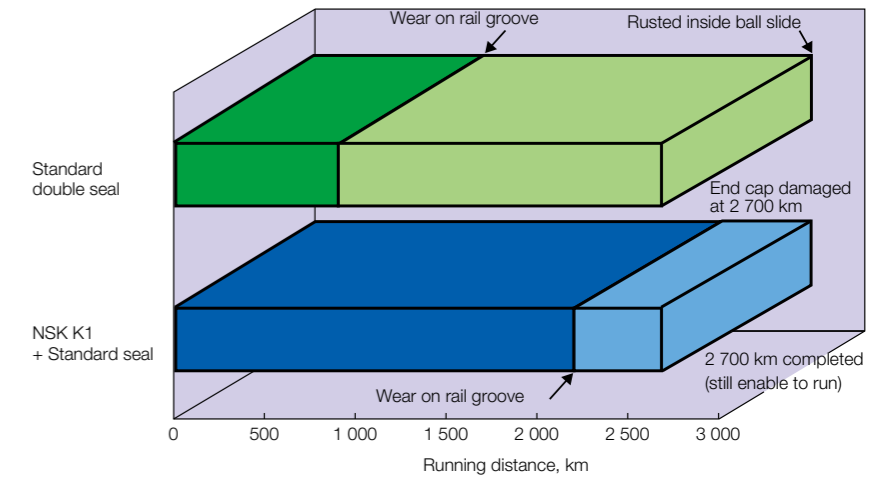

Good Operability (Stable Dynamic friction Force)

Change of oil supply of NSK K1 and dynamic friction force

Test conditions
 Sample: LH30AN, preload Z1 (only with NSK K1)
 Stroke: 800 mm
 Speed: Average 38.4 m/min
 Load: None

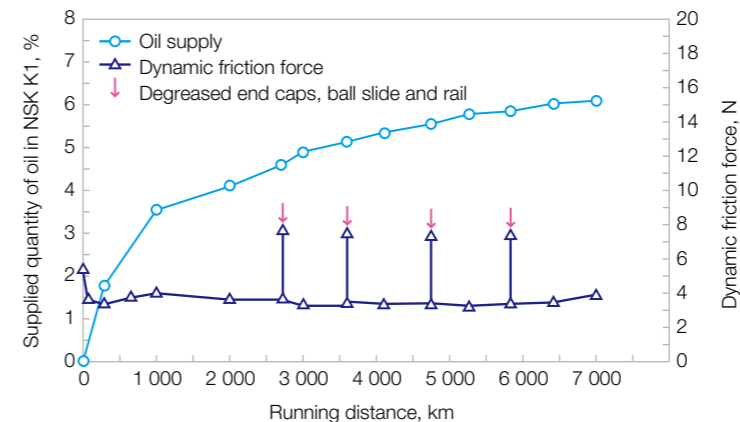

Applications

- Sample preparation systems
- Blood analyzer
- Medical examination tables and bed transfer equipment
- Medical scanner
- Analytic equipment
- Nursing equipment and disabled aids
- Food processing machines
- Food conveyor

Worldwide Sales Offices

P: Phone ☆: Head Office

NSK LTD. HEADQUARTERS, TOKYO JAPAN

INDUSTRIAL MACHINERY BUSINESS DIVISION-HEADQUARTERS P: +81-3-3779-7227
 AUTOMOTIVE BUSINESS DIVISION-HEADQUARTERS P: +81-3-3779-7189

Africa

South Africa:

NSK SOUTH AFRICA (PTY) LTD.

SANDTON P: +27-11-458-3600

Aisia and Oceania

Australia:

NSK AUSTRALIA PTY. LTD.

MELBOURNE ☆ P: +61-3-9765-4400
 SYDNEY P: +61-2-9839-2300
 BRISBANE P: +61-7-3347-2600
 PERTH P: +61-8-9256-5000

New Zealand:

NSK NEW ZEALAND LTD.

AUCKLAND P: +64-9-276-4992

China:

NSK (SHANGHAI) TRADING CO., LTD.

JIANGSU ☆ P: +86-512-5796-3000

NSK (CHINA) INVESTMENT CO., LTD.

JIANGSU P: +86-512-5796-3000
 BEIJING P: +86-10-6590-8161
 TIAN JIN P: +86-22-8319-5030
 CHANGCHUN P: +86-431-8898-8682
 SHENYANG P: +86-24-2334-2868
 DALIAN P: +86-411-8800-8168
 NANJING P: +86-25-8472-6671
 FUZHOU P: +86-591-8380-1030
 WUHAN P: +86-27-8556-9630
 QINGDAO P: +86-532-5568-3877
 GUANGZHOU P: +86-20-3817-7800
 CHANGSHA P: +86-731-8571-3100
 LUOYANG P: +86-379-6069-6188
 XI'AN P: +86-29-8765-1896
 CHONGQING P: +86-23-6806-5310
 CHENGDU P: +86-28-8528-3680

NSK CHINA SALES CO., LTD.

JIANGSU P: +86-512-5796-3000

NSK HONG KONG LTD.

HONG KONG ☆ P: +852-2739-9933
 SHENZHEN P: +86-755-25904886

Taiwan:

TAIWAN NSK PRECISION CO., LTD.

TAIPEI ☆ P: +886-2-2509-3305
 TAICHUNG P: +886-4-2708-3393
 TAINAN P: +886-6-505-5861

TAIWAN NSK TECHNOLOGY CO., LTD.

TAIPEI ☆ P: +886-2-2509-3305
 TAICHUNG P: +886-4-2358-2945
 TAINAN P: +886-6-505-5861

India:

NSK INDIA SALES CO.PVT.LTD.

CHENNAI ☆ P: +91-44-2847-9600
 DELHI P: +91-124-4838000

MUMBAI P: +91-22-2838-7787

Indonesia:

PT. NSK INDONESIA

JAKARTA P: +62-21-252-3458

Korea:

NSK KOREA CO., LTD.

SEOUL P: +82-2-3287-0300

Malaysia:

NSK BEARINGS (MALAYSIA) SDN.BHD.

SHAH ALAM ☆ P: +60-3-7803-8859
 PRAI P: +60-4-3902275
 JOHOR BAHRU P: +60-7-3546290
 IPOH P: +60-5-2555000

Philippines:

NSK REPRESENTATIVE OFFICE

MANILA P: +63-2-893-9543

Singapore:

NSK INTERNATIONAL (SINGAPORE) PTE LTD.

SINGAPORE P: +65-6496-8000

NSK SINGAPORE (PRIVATE) LTD.

SINGAPORE P: +65-6496-8000

Thailand:

NSK BEARINGS (THAILAND) CO., LTD.

BANGKOK P: +66-2320-2555

Vietnam:

NSK VIETNAM CO., LTD.

HANOI P: +84-24-3955-0159

NSK REPRESENTATIVE OFFICE

HO CHI MINH CITY P: +84-28-3822-7907

Europe

United Kingdom:

NSK EUROPE LTD. (EUROPEAN HEADQUARTERS)

MAIDENHEAD P: +44-1628-509-800

NSK UK LTD.

NEWARK P: +44-1636-605-123

France:

NSK FRANCE S.A.S.

PARIS P: +33-1-30-57-39-39

Germany:

NSK DEUTSCHLAND GMBH

DUSSELDORF ☆ P: +49-2102-4810
 STUTTGART P: +49-711-79082-0
 WOLFSBURG P: +49-5361-27647-10

Italy:

NSK ITALIA S.P.A.

MILANO P: +39-299-5191

Netherlands:

NSK EUROPEAN DISTRIBUTION CENTRE B.V.

TILBURG P: +31-13-4647647

Poland:

NSK REPRESENTATIVE OFFICE

WARSAW P: +48-22-645-1525

Russia:

NSK POLSKA SP. Z O.O.

SAINT-PETERSBURG P: +7-812-332-5071

Spain:

NSK SPAIN S.A.

BARCELONA P: +34-93-289-2763

Turkey:

NSK RULMANLARI ORTA DOGU TIC. LTD. STI.

ISTANBUL P: +90-216-477-7111

United Arab Emirates:

NSK BEARINGS GULF TRADING CO.

DUBAI P: +971-4-804-8207

North and South America

United States of America:

NSK AMERICAS, INC. (AMERICAN HEADQUARTERS)

ANN ARBOR P: +1-734-913-7500

NSK CORPORATION

ANN ARBOR P: +1-734-913-7500

NSK PRECISION AMERICA, INC.

FRANKLIN ☆ P: +1-317-738-5000

SAN JOSE

P: +1-408-944-9400

NSK LATIN AMERICA, INC.

MIAMI P: +1-305-477-0605

Canada:

NSK CANADA INC.

TORONTO ☆ P: +1-905-890-0740

MONTREAL

P: +1-514-633-1220

VANCOUVER

P: +1-877-994-6675

Argentina:

NSK ARGENTINA SRL

BUENOS AIRES P: +54-11-4704-5100

Brazil:

NSK BRASIL LTDA.

SAO PAULO ☆ P: +55-11-3269-4700

BELO HORIZONTE

P: +55-31-3274-2591

JOINVILLE

P: +55-47-3422-2239

PORTO ALEGRE

P: +55-51-3346-7851

RECIFE

P: +55-81-3326-3781

Peru:

NSK PERU S.A.C.

LIMA P: +51-1-493-4385

Mexico:

NSK RODAMIENTOS MEXICANA, S.A. DE C.V.

MEXICO CITY ☆ P: +52-55-3682-2900

MONTERREY

P: +52-81-8000-7300

<As of July 2017>

For the latest information, please refer to the NSK website.

www.nsk.com

NSK Ltd. has a basic policy not to export any products or technology designated as controlled items by export-related laws. When exporting the products in this brochure, the laws of the exporting country must be observed. Specifications are subject to change without notice and without any obligation on the part of the manufacturer. Every care has been taken to ensure the accuracy of the data contained in this brochure, but no liability can be accepted for any loss or damage suffered through errors or omissions. We will gratefully acknowledge any additions or corrections.

For more information about NSK products, please contact: _____

